



CURVE
BENDS
COUDES
CODOS



ISS IDF

**CURVA 90° EM.
BEND 90° EE.
COUDE 90° BD.
CODO 90° EM.**

350 I

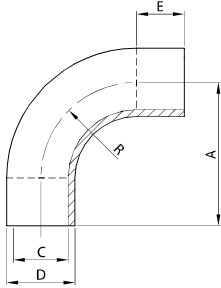

DN	A	C	D	E	R	gr
25	65,0	22,4	25,4	27,0	38,0	90
38	85,0	35,1	38,1	28,0	57,0	180
51	110,0	47,8	50,8	34,0	76,0	300
63	135,0	60,5	63,5	40,0	95,0	490
76	155,0	72,9	76,2	41,0	114,0	900
101	192,5	97,6	101,6	40,0	152,5	1.490

**CURVA 90° BF./BL. G. MT.
BEND 90° MP./L. N. ED.
COUDE 90° PF./PL. E. DN.
CODO 90° M./C. T. MD.**

353 I

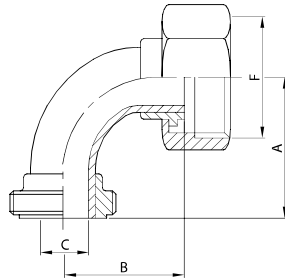

DN	A	B	C	F	gr
25	65,0	65,0	22,4	37-8	355
38	85,0	85,0	35,1	50-8	605
51	110,0	110,0	47,8	64-8	910
63	135,0	135,0	60,5	77-8	1.425
76	155,0	155,0	72,9	91-8	2.050
101	192,5	192,5	97,6	118-8	3.530

**CURVA 90° BF./BF. MT.
BEND 90° MP./MP. ED.
COUDE 90° PF./PF. DN.
CODO 90° M./M. MD.**

354 I

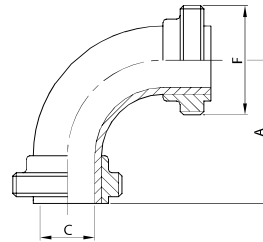

DN	A	C	F	gr
25	65,0	22,4	37-8	190
38	85,0	35,1	50-8	380
51	110,0	47,8	64-8	540
63	135,0	60,5	77-8	880
76	155,0	72,9	91-8	1.420
101	192,5	97,6	118-8	2.580

**CURVA 90° EM.
BEND 90° EE.
COUDE 90° BD.
CODO 90° EM.**

330 L

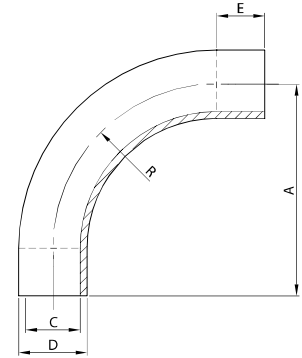

DN	A	C	D	E	R	gr
25	125,0	22,4	25,4	50,0	75,0	190
38	132,0	35,1	38,1	50,0	82,0	300
51	200,0	47,8	50,8	50,0	150,0	630
63	230,0	60,5	63,5	50,0	180,0	870
76	278,0	72,9	76,2	50,0	228,0	1.600
101	354,0	97,6	101,6	50,0	304,0	2.800

**CURVA 180° EL.
BEND 180° PE.
COUDE 180° BL.
CODO 180° EL.**

390 L

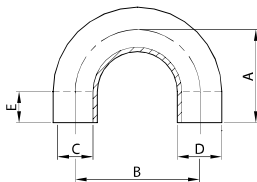

DN	A	B	C	D	E	gr
25	86,5	73,0	22,4	25,4	50,0	170
38	102,0	104,0	35,1	38,1	50,0	250
51	125,5	151,0	47,8	50,8	50,0	480
63	140,0	180,0	60,5	63,5	50,0	700
76	147,0	194,0	72,9	76,2	50,0	1.180
101	150,0	220,0	97,6	101,6	40,0	2.400

**CURVA 180° BF./BF. MT.
BEND 180° MP./MP. ED.
COUDE 180° PF./PF. DN.
CODO 180° M./M. MD.**

391 I

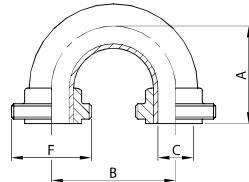

DN	A	B	C	F	gr
25	86,5	73,0	22,4	37-8	270
38	102,0	104,0	35,1	50-8	450
51	125,5	151,0	47,8	64-8	720
63	140,0	180,0	60,5	77-8	1.090
76	147,0	194,0	72,9	91-8	1.700
101	150,0	220,0	97,6	118-8	3.440

**CURVA 180° BF./BL. G. MT.
BEND 180° MP./L. N. ED.
COUDE 180° PF./PL. E. DN.
CODO 180° M./C. T. MD.**

393 I

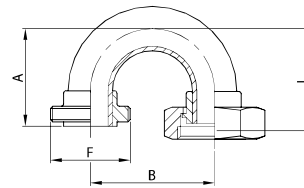

DN	A	B	F	L	gr
25	86,5	73,0	37-8	86,5	435
38	112,0	104,0	50-8	112,0	675
51	125,5	151,0	64-8	125,5	1.090
63	140,0	180,0	77-8	140,0	1.635
76	147,0	194,0	91-8	147,0	2.330
101	150,0	220,0	118-8	150,0	4.390